



Electronic
TUBES

Ham News

Copyright 1954, by General Electric Company

MAY-JUNE, 1954

VOL. 9—NO. 3



PICKING THE PROPER INSULATION

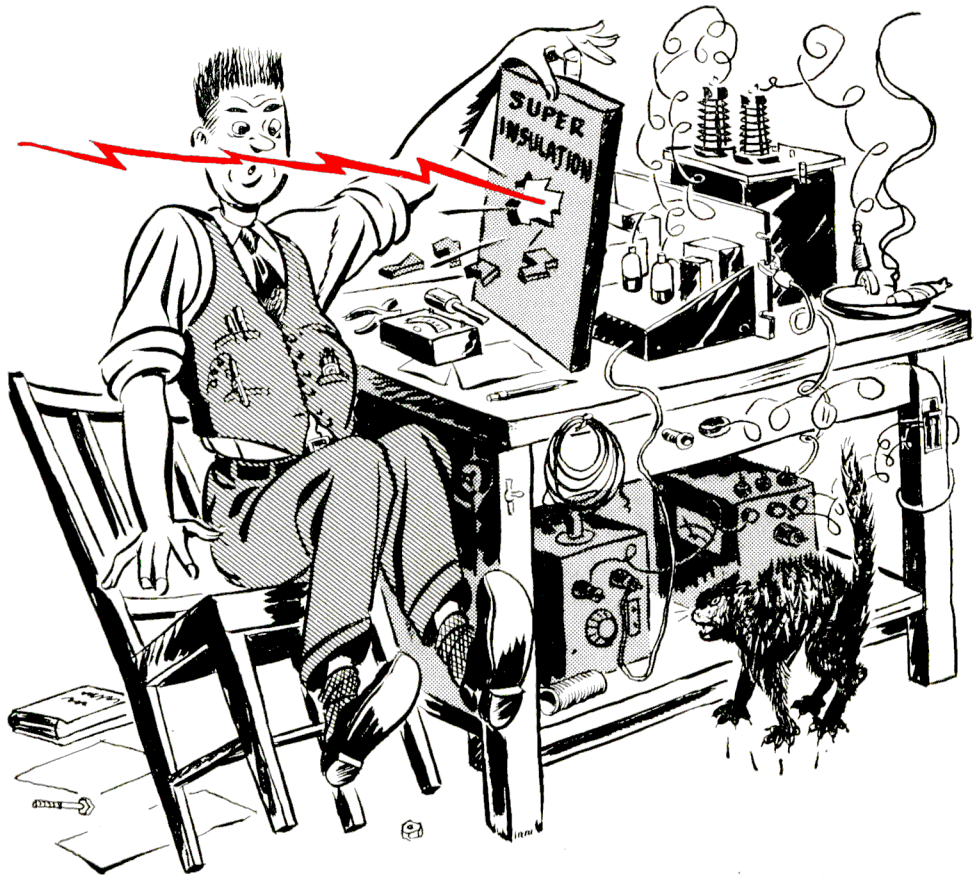

... safety factors are in order ...

Contents

Picking the Proper Insulation	Page 2
1953 Edison Radio Amateur Award Winner	Page 4
Sweeping the Spectrum	Page 7
A Streamlined Rectifier	Page 8

PICKING THE PROPER INSULATION

It is generally recognized the primary function of electrical insulation is to guide current flow through desired paths and to separate electrical circuits and conductors which operate at different voltages. Furthermore, it is evident there are gross differences in the way insulations perform. For example, coils wound on polystyrene forms have a higher "Q" than those wound on molded mud forms; and certain circuits require the use of mica capacitors while in others cheaper paper capacitors will perform satisfactorily.

What are the electrical specifications by which the performance of insulation is measured? What considerations are involved in the selection of the proper insulation for a particular job?

Some specifications (like power factor) are easily

measured and known to a few percent. Others (like puncture strength) are very nebulous and must be used with a great deal of caution in any design application.

Liquid and solid materials are broadly divided into classes according to their ability to conduct electricity. To be specific, when we measure the resistance of a number of liquid and solid materials between two metal plates each 1 inch square and separated by 1 inch (see Figure 1), we find most metals and acids are relatively good conductors of electricity while mineral oil, glass, wood, rubber and plastics are relatively poor conductors. The resistance of a sample having the aforementioned dimensions is called *resistivity* and is measured by a special unit called ohm-inches.

Between the two extremes (*i.e.*, the conductors and

TABLE I
Insulation Specifications* (Measured at 25°C)

Material	Resistivity (ohm-in. at 30% rel. humidity or lower)	Dielectric Constant	Power Factor (%)			Puncture Strength	
			60 cy	1 mc	100 mc	d-c or peak a-c V/mil	Thickness of test sample
INORGANIC							
air	infinite	1	0	0	0	20	
mica	10 ¹³	5-7	0.5	0.04	0.02	600-900	.004"
Mycalex	10 ¹⁵	7	0.64	0.21	0.22	360	.2"
steatite	10 ¹⁴	6	0.2	0.3	0.2	240	.250"
glass (Pyrex)	10 ¹⁴	5	0.8	0.3	0.4	335	
barium titanate	10 ¹³	1200	6.0	1.0	1.0	75 (approx)	
ORGANIC							
Teflon	10 ¹⁶	2.1	0.02	0.02	0.02	250-1600	.012"
polyethylene	10 ¹⁶	2.2	0.01	0.02	0.04	400	.125"
polystyrene	10 ¹⁸	2.6	0.02	0.02	0.05	600	.125"
black Bakelite	10 ¹⁴	5	1.0	0.5	0.5	350	.125"
Lucite Plexiglass	10 ¹⁶	3	6.0	2.0	1.0	500	.125"
Kel-F fluorothene	10 ¹⁸	2.5	2.0	0.9	0.5	400-2500	.125"
hard rubber	10 ¹⁵	3	0.4	6.0	—	400	.125"
paper	—	4	1.0	4.0	6.0	200	.125"

*A large number of the values quoted here taken from the Massachusetts Institute of Technology "Tables of Dielectric Materials."

insulators) lies an intermediate group of materials called semiconductors. We have heard a great deal lately about their use as transistors; however, they conduct electricity too well to be useful as insulation. The arbitrary boundaries in resistivity of semiconductors are generally taken to be 1 ohm-inch and 10^6 ohm-inches.

In Table I are listed a number of materials used as insulation, together with their most important electrical specifications—namely, resistivity, dielectric constant, power factor and puncture strength.

In the first column it will be noted that the resistivity values for these insulators are all a million times or more larger than the upper limit of the semiconduc-

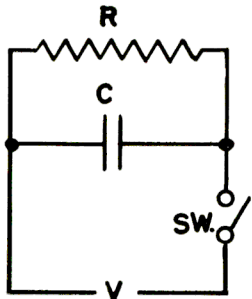

Figure 1

tors. The measurement of such large resistances is not easy, but by using thin samples and 500 volts or more applied to large electrodes, values up to about 10^{16} ohm-inches can be measured accurately. The values quoted in Table I were measured at a relative humidity of 30% or lower. Moisture absorbed within or on the surfaces of high resistivity insulation can seriously lower the values measured.

Consider next the currents that flow through the block of insulation shown in Figure 1 when voltage V is suddenly applied by closing the switch. If V is a d-c voltage, there is a rush of charging current which gradually decays to some steady value determined by the resistivity of the material and the applied voltage. However, when a-c voltage is applied, although most of the current leads the voltage by 90° ($I_{\text{capacitive}}$), a small but measurable current component is in phase with the voltage (I_{ohmic}). The vector diagram of Figure 2 represents these two currents.

Now the ohmic current alone produces heat. The amount of heat is determined by the d-c resistivity of the insulation in conjunction with some extra heat generated when the molecules of the insulation rub against each other as they move under the influence of the a-c voltage.

Thus the cube of insulation could be represented circuit-wise by a resistance shunted across a "perfect" capacitor—that is, a capacitor in which all the current is out of phase with the applied voltage. For "good" insulation of the type we are considering, the ratio of the heat-producing current (I_{ohmic}) to the no-heat-

producing current ($I_{\text{capacitive}}$) is called the power factor of the insulation.

In other words, the power factor is the number by which the "apparent" power* of a capacitor-resistor combination must be multiplied to obtain the actual watts of heat developed. The power factor is a number (usually expressed as a percentage) which can vary from 0% for a perfect insulator such as air to 100% for a perfect conductor.

For most commonly used insulators the power factor

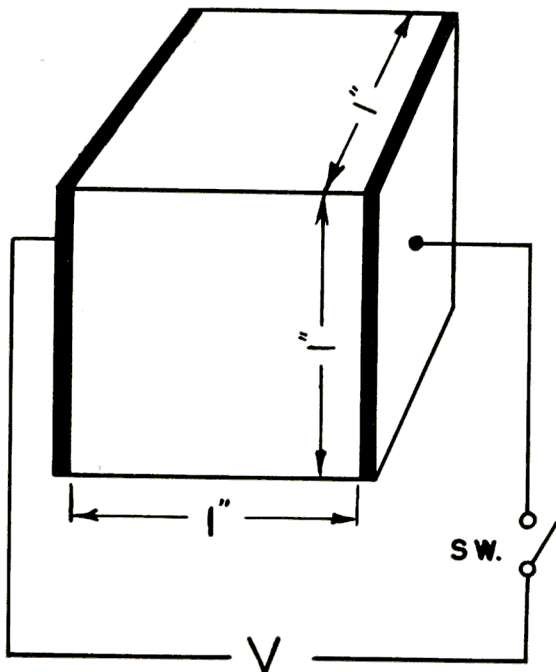

is less than 5%, and it may be as low as .02% for the very best insulators such as polystyrene or mica.

Now as indicated previously, the a-c resistivity of an insulator is in part determined by the movement of the molecules under the influence of the a-c voltage. The net result is to cause the power factor to change in a rather complicated manner with variations in the frequency of the measuring voltage. This is reflected in the power-factor columns in Table I which show it is meaningless to quote a power factor without specifying the frequency at which the measurement was made.

This variation with frequency illustrates why it is of utmost importance in many applications to choose a coil form of suitable material when working with RF circuits. For instance, a paper coil form would have a power factor of 1% at 60 cycles but 6% at 100 megacycles. And in comparing two different types of coil form material it is seen that the power factor of black Bakelite is .5% at 100 megacycles while polystyrene is .05% at the same frequency. Thus the efficiency and Q of an RF circuit can vary well be quite dependent upon the type of insulation used.

* The "apparent power" or "volt-amperes" drawn by a circuit containing both resistance and reactance (as in Fig. 1) is obtained by multiplying the voltage across the circuit by the total current drawn without regard to their relative phases. Actually, power is consumed in the resistor only; the "power" in the capacitor being simply transferred back and forth between the source and the capacitor. Therefore, we define the power factor as the ratio of the actual power consumed by the resistor (which appears as heat) to the apparent power drawn by both resistor and capacitor.

(Continued on page 6)

EDISON RADIO



1953 Edison Radio Amateur Award

J. Stan Surber

W9NZZ

THESE IMPARTIAL JUDGES picked W9NZZ as the radio amateur who performed the most outstanding public service during 1953:

E. ROLAND HARRIMAN

President, The American Red Cross

GEORGE E. STERLING

Commissioner, Federal Communications Commission

GOODWIN L. DOSLAND

President, American Radio Relay League

GARDNER COWLES

President and Editor, "Look" Magazine



The "helping hand" operating this ivory-handled bug (hand-carved from walrus tusk) belongs to W9NZZ, winner of General Electric's 1953 Edison Radio Amateur Award. Though he never tops the monthly BPL list, he'll count words with anyone.



His 20-meter beam stays pointed north to squirt CW to remote weather stations near the Pole where crews are lucky to get mail more than twice a year. (Note Indiana call-letter license plate.)

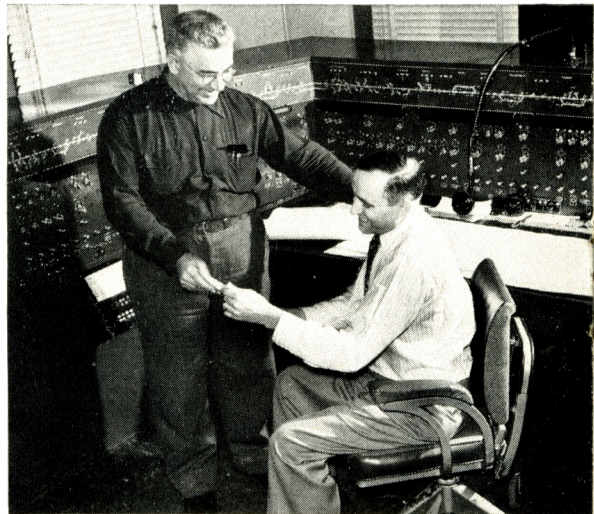

News of winning the Award came via 75-fone from K4AF (MARS) via W9CMT (left) as W9NZZ was on his 4 pm-to-midnight trick as C&O RR dispatcher.

AMATEUR AWARD WINNER



Stan starts each day with early trip to post office to pick up mail for arctic weather men. In 1953 he kept regular skeds with arctic stations 353 days.



XYL Louise serves lunch at the rig so he can keep two skeds with each station most days. She won a wrist watch from G.E. as a "Most Understanding Wife." Louise works the same hours as the OM as PBX operator for C&O.



Stan loves to explain his hobby to neighbors (left) and gets many souvenirs from devoted friends he has never seen (above). Traffic piled up when Award ceremonies broke up skeds—but he reports operations now on a current basis again.

PICKING THE PROPER INSULATION

(Cont'd from page 3)

It is a familiar fact that the capacity of a condenser depends on the area and separation of the plates, but perhaps not nearly so well appreciated is the fact that capacity also depends on the *kind* of material between the plates. This has led to the use of the dimensionless quantity called the dielectric constant which usually is denoted by the letter K.

Suppose we measure the capacity of the condenser of Figure 1 first with a solid insulation between the plates and then with just air between the plates. The capacitance obtained with the solid insulation divided by the capacitance obtained with air insulation gives us the dielectric constant. In this way, the K of air is always 1. The K of the so-called "high-K" materials like barium titanate may have a value of more than 1000 (see Table I).

The principal effect of this number is to determine the capacitance per cubic inch that may be obtained in a capacitor. Thus a capacitor made with mica insulation could be made more compact than a paper-insulated capacitor of the same value since the dielectric constant of paper is 2 and mica is 7. For the same reason, a Pyranol filled capacitor is much smaller than an oil-filled capacitor of the same value.

The last of the more important electrical ratings assigned to insulation is the "puncture" or dielectric strength. This usually is expressed in volts per mil, and gives the measure of the amount of voltage necessary to puncture a piece of insulation. While the puncture strengths in Table I are quoted in volts per mil of insulation thickness, these values are not scalable over a wide range of thickness. The puncture strengths in Table I apply to measurements made with flat electrodes with carefully polished and rounded edges on insulation about $\frac{1}{8}$ inch thick. This condition rarely is attained in practice with the result the strengths listed in Table I are all apt to be higher than would be encountered in practical situations. Thus safety factors of the order of 100% must be applied to any design based on these numbers.

Although such a listing of puncture strengths is qualitative at best, the following generalizations may be made: (a) Gases (like air) at ordinary pressures have puncture strengths about ten times lower than most solids; and (b) solid insulators $\frac{1}{8}$ to $\frac{1}{4}$ inch thick have strengths of several hundred volts/mil except in the case of mica and very thin plastic sheets (a few mils) which may have a puncture strength as large as 1000 volts/mil.

A fact worth noting is that breakdown usually culminates in a high-temperature arc. While this is of little consequence with air and ceramic insulation, organic insulation will be charred by the arc and the carbon track created will then break down at a much lower voltage than that which caused the initial failure. This fact may be of importance when selecting an insulation for high voltage applications where arcing is expected. Often breakdowns occur in transformers where voltage taps are brought out from the windings. If the charred varnished cambric insulation is carefully cut away with a knife or razor blade, and the resulting void filled with plastic cement such as Glyptal, the transformer may sometimes be saved.

Breakdown between two conductors in certain situations may be eliminated by inserting a sheet of solid insulation between them. A piece of mica or thin sheet of plastic often will do the trick.

Sharp points on conductors cause breakdown at lower voltages than will occur with smooth-surfaced conductors under otherwise equal conditions. Thus, care

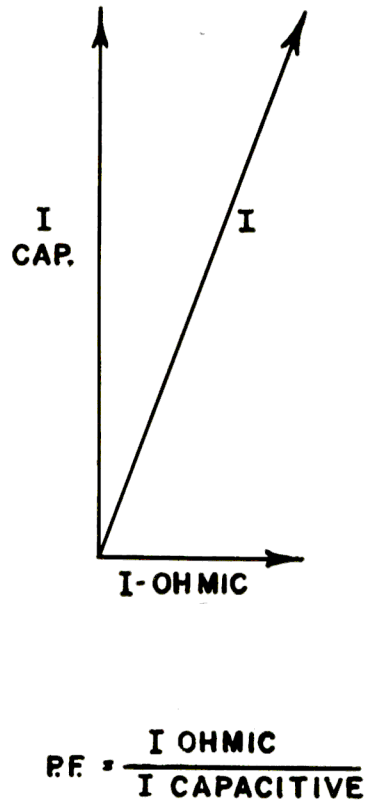

Figure 2

should be taken to polish capacitor plate edges, keep the plates dust-free and to round-off conductors in high-voltage circuits. For example, globlets of solder will sufficiently smooth the ends of two pieces of No. 10 wire that have been cut with side cutters so that the breakdown voltage rating of the gap will be doubled.

A discussion of insulation would not be complete without mention of the effect of moisture. Moisture will lower the breakdown voltage of many kinds of insulation, especially the paper and cloth varieties. Thus, it is wise to allow ample "dry-out" time of high-voltage gear that has been stored in damp locations.

Furthermore, moisture absorbed on the surfaces of plastics will cause their power factors (and attenuation per foot) to rise. Almost every ham who has operated in wet weather with twin conductors insulated with polyethylene has noticed this effect. By actual measurement at 100 megacycles, the attenuation per hundred feet of one variety of twin lead conductors increased from 1.2 decibels to 6.5 decibels when its surface was wet. The application of water-repellent materials like silicones to these surfaces often will improve performance of insulation under adverse moisture conditions.

All the values quoted in Table I apply to measurements made at room temperature. Generally speaking, at higher temperatures the performance of insulating materials becomes poorer. As the operating temperature of a given insulation is raised, the resistivity, dielectric constant, and puncture voltage becomes lower while the power factor rises—W2UKL.

SWEEPING *the* **SPECTRUM**

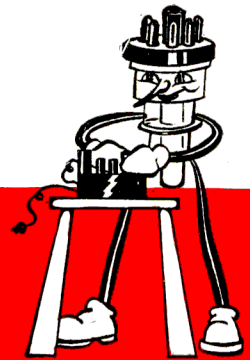

Judging from the requests we've had for back copies of G-E HAM NEWS concerned with SSB, the rush to this type of emission definitely is on.

SSB fone work is so fast that there are an awful lot of long silences in these QSOs. Even the most long-winded fone men find they can run out of steam pretty fast on SSB.

One result of this situation has been the building up of super round tables—round tables of a size that would be completely impractical in push-to-talk operation. But in SSB's talk-to-talk operation anyone can stick in his two cents just by speaking up.

Did we say "anyone"? We'll correct that. All the higher-power boys in the round tables merely speak up. But the unfortunate low-power boys (5 watts peak or so) have a kind of rough time in these super round tables because everyone has his receiver turned down so the roof won't blow off when the 4-250As speak up. So even though the 6AG7 boys can work all districts without straining their filaments, they get lost in the round tables. Thus the rush is on not only to SSB, but to high-power SSB!

One thing is lacking in the SSB world as we write—honest-to-goodness traffic nets. SSB offers perhaps more to the traffic men than to other operators. So far, SSB has been the pride and joy of, first, the more technical-minded hams and now the rag-chewers. But as equipment and circuits become more standardized and we find ways to lick the stability problem, we feel SSB has a future in traffic work.

Don't think for a moment we mean that the technicians and rag-chewers are going to turn into trafficmen en masse. Not at all. The biggest single factor in traffic nets are the operators—the guys and gals with a particular kind of intense persistence and whose main objective in life is to "get that message through." They're born, not made. And we feel sure that when they latch onto SSB communications, there'll be no stopping them. Of course, a complete change-over on an entire traffic net is a problem not wholly technical—a problem of economics. (How many lads can afford to scrap an AM rig they've given, in effect, their life's blood to acquire?) The transition will be slow. But we feel that now is the time to start planning and operating SSB TFC.

Don't think that with all this talk of fone work we're slighting good, reliable CW. We ask around among our friends every once in a while about whether they prefer fone or CW—and it's about half and half as far as we can figure. Lots of fellows like to work both. Our editor himself said he's probably the worst CW man in the world—but just the same he likes it best.

So we're keeping eyes open for good CW rigs, too. One of the best 80/40-meter CW rigs we know of is the "Economy Half-Kilowatt" described in G-E HAM NEWS, Volume 3, No. 5. It's a two-control, two-stage VFO job that's a delight to operate. It uses a 1614 (but

a 6L6 works fine) and a GL-4D21/4-125A. Be glad to send you one of these back copies.

In Cardiff, Wales, a case of TVI was traced to the 42-inch pendulum of a spring grandfather clock, and was remedied by grounding the metal works, according to "Sparks," the Brandon, Manitoba, club bulletin . . . the Ak-Sar-Ben Club of Omaha, reports "Ham Hum," has started an annual award (a first-class communications receiver) for the member who will be adjudged as having done the most for amateur radio during 1954 . . . the same bulletin reports 25 SSB stations in the Northeast Nebraska area where only 2 operated a year ago . . . Old-timers' hearing tapers off at 10,200 cps or so while the younger lads easily catch 15,000 cps, according to W9UIA in a talk on loud-speaker problems at a meeting of Tri-State ARA at Evansville, Ind. WN9YZO, a medico, says this is due to hardening of the inner ear with age . . .

Hams long have been known for the fine job they do in policing their own ranks. Recent comments from OO's, for example, indicate that their friendly warnings to brother hams are received in good grace and with fervent thanks in nearly every case.

Now we note comments in two widely separated local ham club bulletins which indicate some organized self-policing may be in order in a new field—among those fortunate enough to be granted auto license plates bearing their call letters.

The license plate program has met with considerable success throughout the nation—and has given us a great boost in publicity. In many cases we are thus put on a level with doctors and other public servants.

However, as we attain this stature we also have to remember that it behooves us to live up to our new standing—by added care and courtesy on the road. Need more be said than to comment that every traffic ticket a ham with call-letter license plates gets is a black eye for ham radio? And suppose through our carelessness it should be something worse than just a "ticket"? Suppose it's a broken, twisted body of a child on the highway? We see such pictures in the newspaper once in a while. And I fervently hope I never see one which includes a "murder car" bearing ham call-letter license plates.

You think this is a painful and unpleasant subject? Sure is. But not half as painful and unpleasant as the real thing. We bring it up in the hopes that a few thoughts now, beforehand, may prevent the real thing from ever happening.

—Lighthouse Larry

A STREAMLINED RECTIFIER

The new "Service-Designed" GL-5U4-GA has slightly higher output voltage and current ratings than the old 5U4-G and a streamlined envelope and sturdier construction—all of which make it more adaptable to ham use.

Here's the difference:

	OLD 5U4-G	NEW 5U4-GA
MAXIMUM RATINGS		
Steady state peak current per plate, 675 ma		900 ma
Transient peak current per plate (Maximum duration 0.2 second) . . . 4.0 amp		4.3 amp
TYPICAL OPERATION		
<i>With capacitor-input filter:</i>		
AC Plate supply voltage per plate,		
RMS 450 volts	450 volts	
Filter input capacitor 10 mfd	40 mfd	
DC output current 225 ma	250 ma	
<i>With choke-input filter:</i>		
AC Plate supply voltage per plate,		
RMS 550 volts	550 volts	
Filter input choke 3 hy	10 hy	
DC output current 225 ma	250 ma	
Tube voltage drop (at 225 ma load) . 50 volts	44 volts	

The envelope is shorter and narrower than the old model, and thus saves space. Note the mica support at bottom as well as top—which together with the new "button stem" construction makes a sturdier tube.

Shock and vibration tests show the new 5U4-GA can withstand the hard usage of Field Day and portable operation.

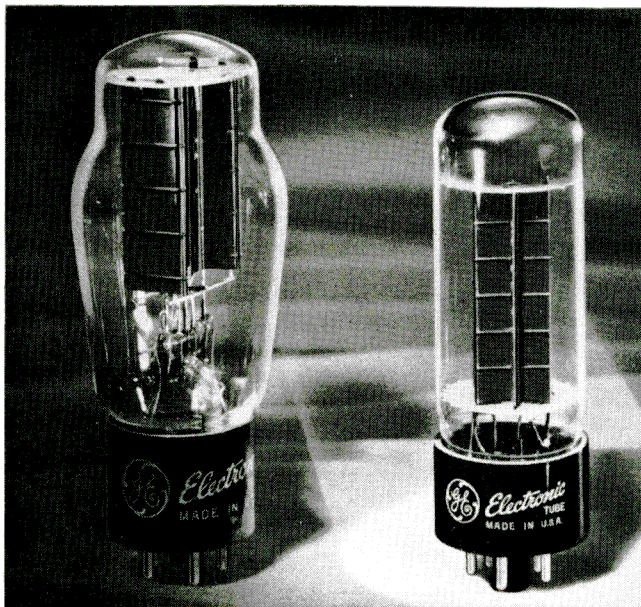

OLD 5U4-G

GL-5U4-GA



Ham News

Available FREE from

G-E Electronic Tube Distributors

A Bi-monthly Publication

TUBE DEPARTMENT

GENERAL ELECTRIC

Schenectady 5, N. Y.

In Canada, Canadian General Electric Company, Ltd., Toronto, Ont.

S. E. McCALLUM, W2ZBY—EDITOR